



SINCE 1992

HANDS, HEART, INTUITION, COURAGE, STRIVING TO IMPROVE WITHOUT COMPROMISE.



LAGO is a family owned company; a 60 years experienced prominent and respected producer of truck and trailer accessories: tool and storage boxes, system mudguards, fire extinguisher boxes together with other complementary products. Established in Italy and able to bring out the expertise of every resource and export it to over 50 countries, along with recognized business ethics and fairness towards its partners.

At LAGO we stay true to our roots and values, without ever forgetting where we began at the longstanding Fontaniva headquarters, where everything still happens.

Our journey never stops, because settling for second best is simply not in our DNA. Moving forward there will always be a solution that is more complete, more practical, more efficient, a system that no-one has yet thought of.



LIGO

made in italy

TANKY

HAND WASH WATER TANK



UV stabilized polyethylene

Colour: black, (UV stabilized)
not suitable for food stuff

Strong and handy

All tanks pressure tested
Threaded 250ml soap pump - Dispenser and tap included
Necessary hardware for Tanky/bracket fastening included

Tanky 30

Code	capacity (liters)	colour	A	b-B	C	kg
110.0602	28	black	350	360-380	430	3

Tanky 50

110.0603	45	black	420	430-450	450	5,2
----------	----	-------	-----	---------	-----	-----

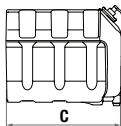
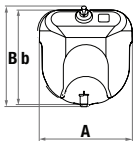

TANKY SUPPORT BRACKET KITS

Support bracket kits

Code	description	fig.
110.0604	Chassis mounting fitting brackets - Tanky 30 and 50	A
110.0605	Platform mounting fitting brackets - Tanky 30 and 50	B

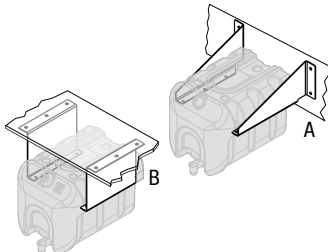

all dimensions are in mm

TANKY SPARE PARTS

Code	description	fig.
110.0606	Soap dispenser kit (with tank)	A
110.0607	Water tap	B
110.0608	Tank cap (alternative to soap dispenser kit)	C



FORMEEGA

OSY/TP
130

SIDE UNDERRUN PROTECTION

Side underrun protection devices are a great investment to reduce the chance of an accident when a cyclist or pedestrian may fall under the wheels of a truck.

Now a requirement for all construction trucks involved in the Melbourne Metro project, we can expect further demand for side underrun protection devices in the upcoming future. This will allow an improvement in road user safety and potentially reduce fuel consumption.

Lago side underruns have been manufactured to meet most makes and models of trucks and trailers. Compliant with ECE R73.01 standard regulations, Lago side underruns are light weight. Manufactured in Italy with premium quality materials such as aluminium and galvanised steel, Lago side underruns are supplied in complete kit and ready to bolt on.

LATERAL UNDERRUN PROTECTION DEVICES

SIDE BASIC SET

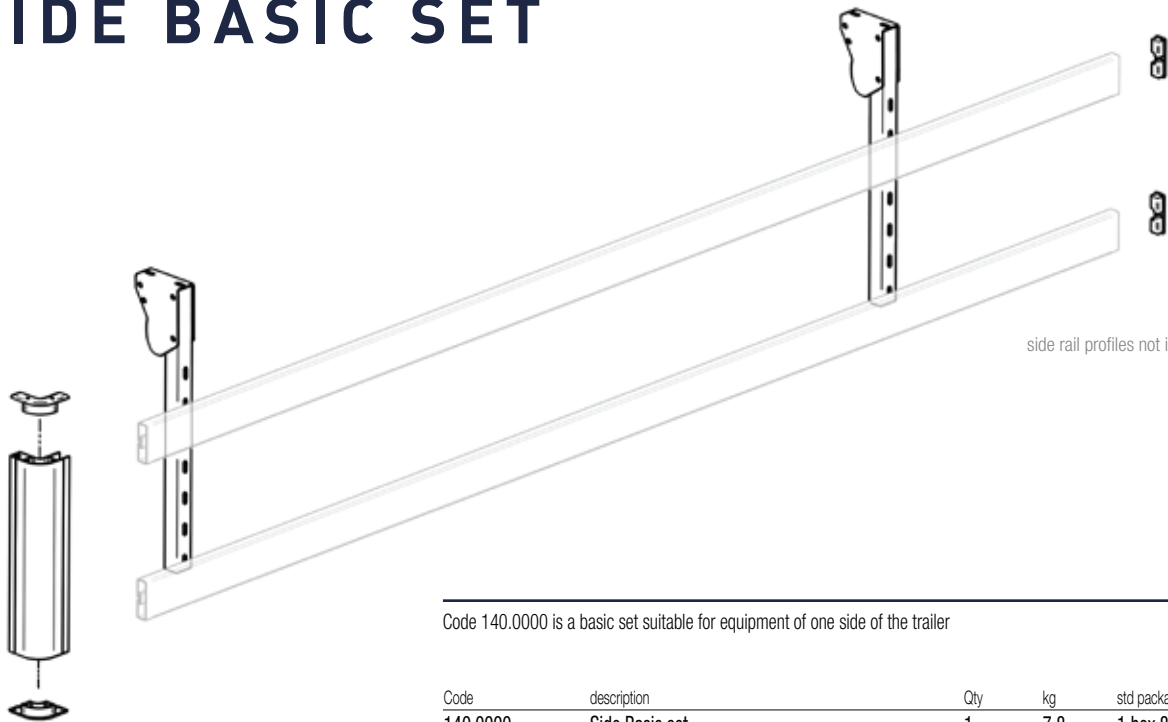

Code 140.0000 is a basic set suitable for equipment of one side of the trailer

Code	description	Qty	kg	std packaging
140.0000	Side Basic set	1	7,8	1 box 800X160X130 mm*

Set composition:

Pair of spring loaded adjustable VIP brackets	1
Anodized aluminium 6060 T6 corner element	1
Corner element end caps 100x100	2
Side rail profile end caps 100x30	2

*side rail profiles not included in the set

VIP

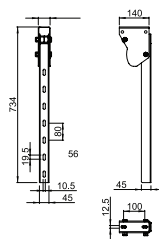
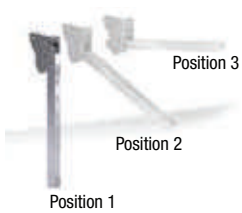

Galvanized metal Steel S235JR

Vip Spring loaded adjustable bracket (3 position settings)

Code	description	kg
140.0001	Vip brackets	5,2

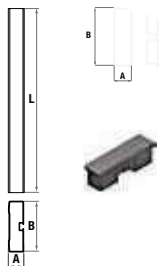

Anodized aluminium 6060 T6

Code	description	A	B	L	kg
140.0002	Side rail profile	30	100	3250	3,9

all dimensions are in mm

Check which specific product configuration is type-approved according to regulation ECE 73R01 under download section www.lagoaccessori.it



WE MAKE ANY TRUCK YOUR TRUCK | **LAGOACCESSORI.IT**